

TITLE: V22d	
Document Number:	REV:
Date: 9/17/2003 16:16:30	Sheet: 1/2

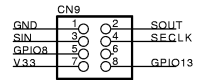
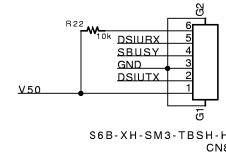
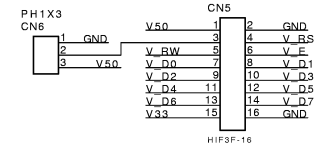
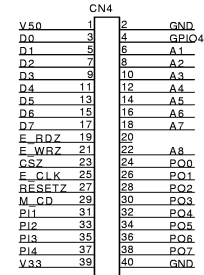
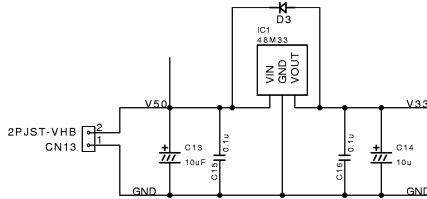
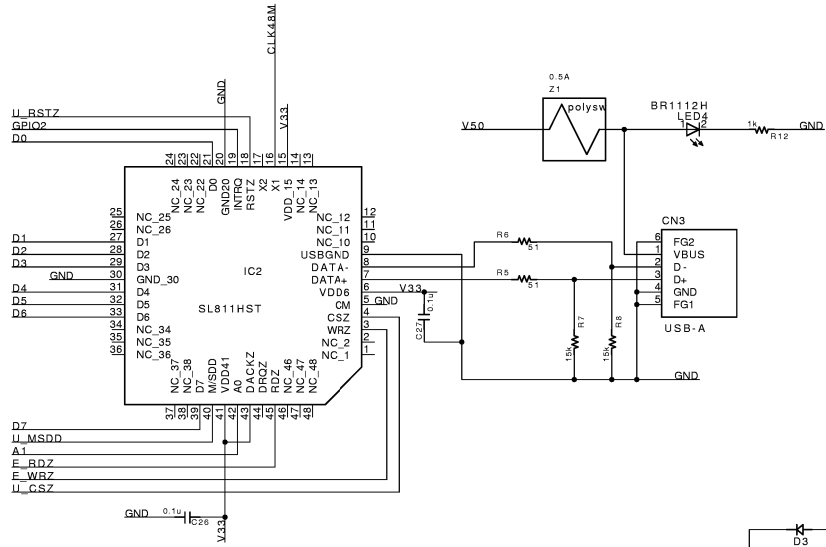
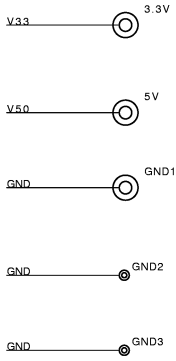
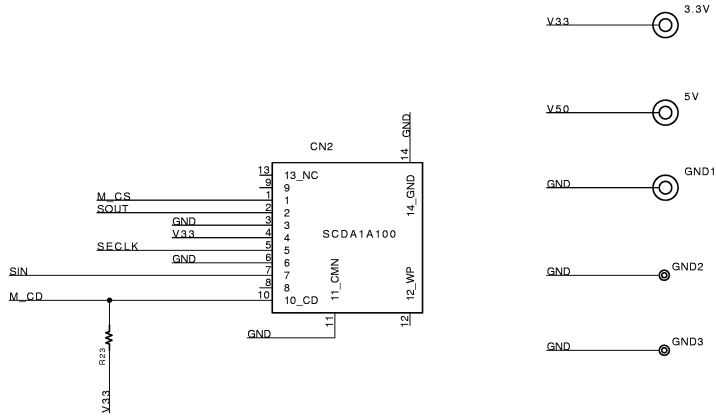

TITLE: U22d	
Document Number:	REV:
Date: 9/17/2003 16:16:30	Sheet: 2/2